

FASTERHOLT

3700073, 72951001
3700122, 72952001

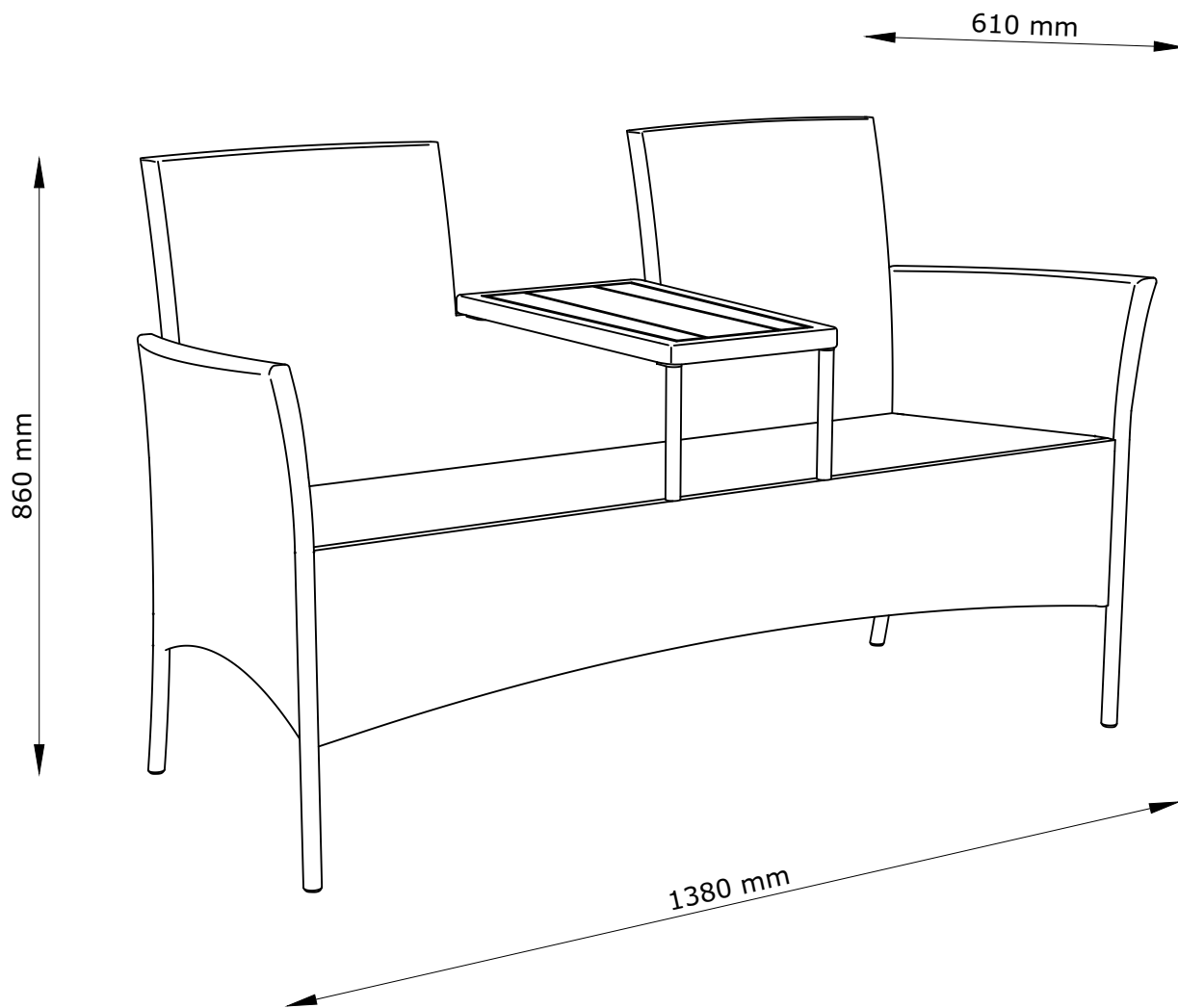

FR
Pensez à
donner ou recycler.



ou



ou





Déchèterie

<https://quefairedemesdechets.fr>

- GB:** *IMPORTANT, RETAIN FOR FUTURE REFERENCE: READ CAREFULLY.*
- DK:** *VIGTIGT, GEMMES TIL SENERE BRUG: LÆS OMHYGGELIGT.*
- DE:** *WICHTIG, FÜR SPÄTERE BEZUGNAHME AUFBEWAHREN: SORGFÄLTIG LESEN.*
- NO:** *VIKTIG. MÅ OPPBEVARES FOR SENERE BRUK: MÅ LESES NØYE.*
- SE:** *VIKTIGT – SPARAS FÖR FRAMTIDA BRUK: LÄS NOGA.*
- FI:** *TÄRKEÄÄ, SÄILYTÄ MYÖHEMPÄÄ TARVETTA VARTEN: LUE HUOLELLISESTI.*
- PL:** *WAŻNE, ZACHOWAĆ NA PRZYSZŁOŚĆ: PRZECZYTAĆ UWAŻNIE.*
- CZ:** *DŮLEŽITÉ, USCHOVEJTE PRO POZDĚJŠÍ POUŽITÍ: ČTĚTE POZORNĚ.*
- HU:** *FONTOS, ŐRIZZE MEG A KÉSŐBBIEKRE: OLVASSA EL FIGYELMESEN.*
- NL:** *BELANGRIJK, BEWAREN VOOR TOEKOMSTIG GEBRUIK: ZORGVULDIG LEZEN.*
- SK:** *DÔLEŽITÉ, INFORMÁCIE SI ODLOŽTE NA POUŽITIE V BUDÚCNOSTI: ČÍTAJTE POZORNE.*
- FR:** *IMPORTANT, À CONSERVER POUR TOUTE CONSULTATION ULTÉRIEURE: LIRE ATTENTIVEMENT.*
- SI:** *POMEMBNO, SHRANITE ZA POZNEJŠO UPORABO: POZORNO PREBERITE.*

- HR:** VAŽNO, SPREMI TE ZA BUDUĆU UPOTREBU:
POZORNO PROČITAJTE.
- IT:** IMPORTANTE, CONSERVARE PER
CONSULTAZIONI FUTURE: LEGGERE
ATTENTAMENTE.
- ES:** IMPORTANTE: CONSERVAR PARA FUTURAS
CONSULTAS Y LEER DETENIDAMENTE.
- BA:** VAŽNO, SAČUVAJTE ZA UBUDUĆE:
PAŽLJIVO PROČITAJTE.
- RS:** VAŽNO, SAČUVAJTE ZA BUDUĆU
UPOTREBU: PAŽLJIVO PROČITAJTE.
- UA:** УВАГА! ЗБЕРЕЖІТЬ ЦЮ ІНСТРУКЦІЮ ДЛЯ
ВИКОРИСТАННЯ В МАЙБУТНЬОМУ.
УВАЖНО ОЗНАЙОМТЕСЯ З ІНСТРУКЦІЄЮ.
- RO:** IMPORTANT, PĂSTRAȚI PENTRU
CONSULTARE ULTERIOARĂ: CITIȚI CU
ATENȚIE.
- BG:** ВАЖНО, ЗАПАЗЕТЕ ЗА БЪДЕЩА СПРАВКА:
ПРОЧЕТЕТЕ ВНИМАТЕЛНО.
- GR:** ΣΗΜΑΝΤΙΚΟ, ΦΥΛΑΞΤΕ ΓΙΑ ΜΕΛΛΟΝΤΙΚΗ
ΑΝΑΦΟΡΑ: ΔΙΑΒΑΣΤΕ ΠΡΟΣΕΚΤΙΚΑ.
- PT:** IMPORTANTE, CONSERVE PARA
REFERÊNCIA FUTURA: LEIA COM ATENÇÃO.
- RU:** ВАЖНАЯ ИНФОРМАЦИЯ, СОХРАНИТЕ ДЛЯ
ДАЛЬНЕЙШЕГО ИСПОЛЬЗОВАНИЯ.
ПРОЧТИТЕ ВНИМАТЕЛЬНО.
- TR:** ÖNEMLİ, GELECEKTE BAŞVURMAK İÇİN
SAKLAYIN: DİKKATLE OKUYUN.
- CN:** 重要信息，请妥善保存供日后参考：请仔细
阅读。

EN581		
		
✓	✓	✗

GB: *Domestic use.*

DK: *Husholdningsbrug.*

DE: *Nutzung im Wohnbereich.*

NO: *Privat bruk.*

SE: *Hemmabruk.*

FI: *Kotikäyttöön.*

PL: *Do użytku na zewnątrz domu.*

CZ: *Určeno pro domácí použití.*

HU: *Lakásban való használatra.*

NL: *Thuisgebruik.*

SK: *Určené na domáce použitie.*

FR: *Pour la maison.*

SI: *Domača uporaba.*

HR: *Za upotrebu u kućanstvu.*

IT: *Usò domestico.*

ES: *Usò doméstico.*

BA: *Upotreba u domaćinstvu.*

RS: *Za upotrebu u okviru domaćinstva.*

UA: *Для домашнього використання.*

RO: *Pentru uz casnic.*

BG: *За употреба в домашни условия.*

GR: *Για οικιακή χρήση.*

PT: *Usò doméstico.*

RU: *Для домашнего использования.*

TR: *Ev içi kullanım.*

CN: *家庭用.*



- GB: WARNING FOR SEATING FURNITURE!**
Tested for 110 kg. per seat.
- DK: ADVARSEL VEDRØRENDE SIDDEMØBLER!**
Testet for 110 kg. pr. siddeplads.
- DE: WARNUNG FÜR SITZMÖBEL!**
Getestet für 110 kg je Sitz.
- NO: ADVARSEL FOR SITTEMØBEL!**
Testet for 110 kg per sitteplass.
- SE: VARNING GÄLLANDE SITTMÖBLER!**
Testad för 110 kg per sits.
- FI: ISTUINHUONEKALUA KOSKEVA VAROITUS!**
Testattu 110 kg:lle istuinta kohden.
- PL: OSTRZEŻENIE DOTYCZĄCE SIEDZISKA!**
Przetestowane obciążenie: 110 kg/siedzisko.
- CZ: VAROVÁNÍ PRO SEDACÍ NÁBYTEK!**
Testováno na 110 kg na sedák.
- HU: ÜLŐBÚTORRAL KAPCSOLATOS FIGYELMEZTETÉS!**
A vizsgálati terhelés ülésenként 110 kg volt.
- NL: WAARSCHUWING VOOR ZITMEUBILAIR!**
Getest voor 110 kg. per stoel.
- SK: VÝSTRAHA PRE SEDACÍ NÁBYTOK!**
Testovaný na hmotnosť 110 kg na sedadlo.
- FR: AVERTISSEMENT POUR LE MOBILIER D'ASSISE!**
Testé pour un poids de 110 kilos par assise.
- SI: OPOZORILO ZA SEDEŽNO POHIŠTVO!**
Preskušeno za 110 kg/sedež.
- HR: UPOZORENJE O NAMJEŠTAJU ZA SJEDENJE!**
Testiran je za težinu od 110 kg po sjedalu.
- IT: AVVERTENZA PER SEDUTE D'ARREDO!**
Testate per 110 kg per seduta.
- ES: ¡ADVERTENCIA PARA ASIENTOS!**
Probado para 110 kg por asiento.
- BA: UPOZORENJE ZA NAMJEŠTAJ ZA SJEDENJE!**
Testirano za 110 kg po sjedištu.
- RS: UPOZORENJE VEZANO ZA NAMEŠTAJ ZA SEDENJE!**
Testirano na 110 kg po mestu za sedenje.
- UA: ПОПЕРЕДЖЕННЯ ЩОДО ВИКОРИСТАННЯ МЕБЛІВ ДЛЯ СИДІННЯ!**
Максимальне навантаження 110 кг на одне сидіння.
- RO: ATENȚIONARE PRIVIND MOBILIERUL PENTRU ȘEZUT!**
Testat pentru 110 kg per piesă de mobilier pentru șezut.
- BG: ПРЕДУПРЕЖДЕНИЕ ЗА МЕБЕЛИ ЗА СЯДАНЕ!**
Преминала изпитания за тегло 110 кг на седалка.
- GR: ΠΡΟΕΙΔΟΠΟΙΗΣΗ ΓΙΑ ΤΑ ΚΑΘΙΣΜΑΤΑ!**
Δοκιμασμένα για 110 κιλά ανά θέση.
- PT: AVISO PARA CADEIRAS!**
Testadas para 110 kg por cadeira.
- RU: ПРЕДУПРЕЖДЕНИЕ ДЛЯ МЯГКОЙ МЕБЕЛИ!**
Максимально допустимый вес - 110 кг. на одно посадочное место.
- TR: BÜRO SANDALYELERİNE YÖNELİK UYARI!**
110 kg için test edilmiştir.
- CN: 座椅警告信息!**
测试重量为每个椅子 110 kg.

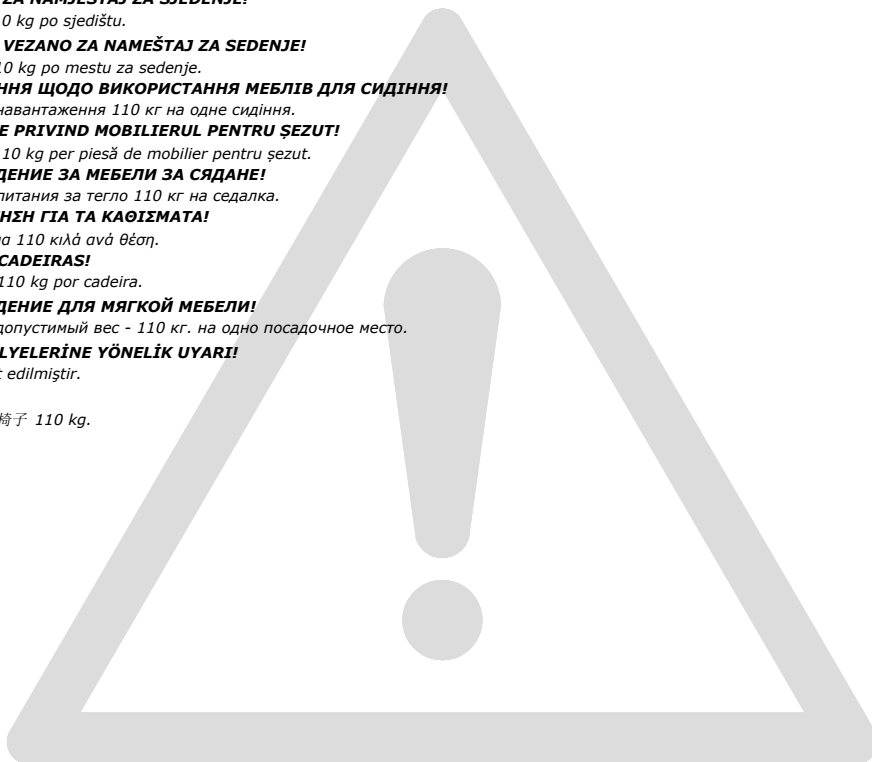

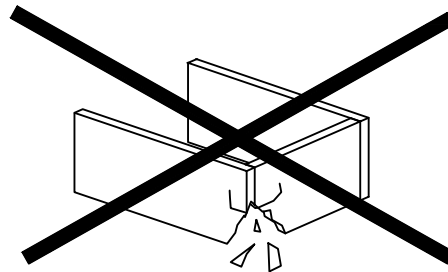
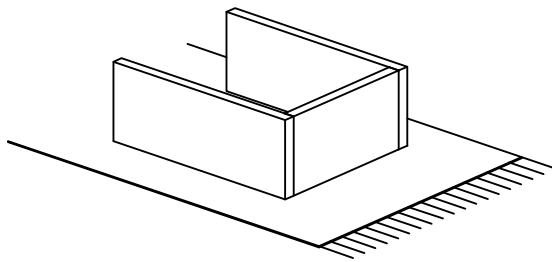

GB: WARNING TO AVOID SCRATCHES!

In order to avoid scratching this furniture should be assembled on a soft layer - could be a rug.

DK: ADVARSEL FOR AT FORHINDRE RIDSER!

For at forhindre ridser skal dette møbel samles på et blødt underlag, f.eks. et tæppe.

DE: HINWEIS ZUR VERMEIDUNG VON KRATZERN!

Um Kratzer zu vermeiden, sollte dieses Möbelstück auf einer weichen Unterlage montiert werden (z. B. Teppich).

NO: ADVARSEL FOR Å UNNGÅ RIPER!

For å unngå riper må møbelet monteres på et mykt underlag, for eksempel et teppe.

SE: VARNING OM HUR DU UNDVIKER REPOR!

För att undvika repor ska denna möbel monteras på ett mjukt underlag, exempelvis en matta.

FI: VARO NAARMUJA!

Varo naarmuja ja kokoa tämää kaluste pehmeällä alustalla, esimerkiksi maton päällä.

PL: OSTRZEŻENIE WS. USZKODZEŃ!

Aby uniknąć rys, ten mebel powinien być montowany, składany na miękkim podłożu, np. dywanie.

CZ: VAROVÁNÍ TÝKAJÍCÍ SE POŠKRÁBÁNÍ!

Aby nedošlo k poškrábání, sestavujte nábytek na měkkém podkladu – např. na koberci.

HU: KARCOLÁSOK MEGELŐZÉSE - FIGYELEM!

A karcolások megelőzése érdekében a bútort puha felületen, például szőnyegen kell összeszerelni.

NL: WAARSCHUWING OM KRASSEN TE VERMIJDEN!

Om te voorkomen dat dit meubel krassen vertoont, moet het gemonteerd worden op een zachte ondergrond - zoals een tapijt.

SK: VÝSTRAHA TÝKAJÚCA SA PREDCHÁDZANIA ŠKRABANCOM!

Aby sa predišlo škrabancom, tento nábytok by sa mal montovať na mäkkom podklade, napríklad na koberci.

FR: AVERTISSEMENT POUR ÉVITER LES RAYURES!

Afin d'éviter les rayures, ce meuble doit être monté sur une surface souple (un tapis, par exemple).

SI: KAKO PREPREČITI PRASKE!

Da bi se izognili praskam na pohištvu, pohištvo sestavite na mehki podlagi, npr. na preprogi.

HR: UPOZORENJE O IZBJEGAVANJU OGREBOTINA!

Kako bi se izbjegle ogrebotine, ovaj proizvod potrebno je sastavljati na mekanoj površini - primjerice, na tepihu.

IT: AVVERTENZA PER EVITARE I GRAFFII!

Per evitare i graffi, si raccomanda di montare questo mobile su una superficie morbida (come ad es. un tappeto).

ES: ADVERTENCIA PARA EVITAR RAYADURAS!

Para no rayar este mueble, es aconsejable ensamblarlo sobre una superficie suave (posiblemente una alfombra).

BA: UPOZORENJE ZA SPRJEČAVANJE NASTANKA OGREBOTINA!

Da bi se izbjegle ogrebotine na ovom namještaju, poželjno ga je sastaviti na mekoj podlozi - na primjer, tepihu.

RS: UPOZORENJE ZA IZBEGAVANJE OGREBOTINA!

Da biste izbegli ogrebotine, ovaj nameštaj treba da sastavljate na mekoj podlozi - može prostirka.

UA: ПОПЕРЕДЖЕННЯ ЩОДО ПОДРЯПИН!

Щоб уникнути подряпин, ці меблі слід збирати на м'якій поверхні, наприклад, на килимі.

RO: ATENȚIONARE PENTRU EVITAREA ZGĂRIERII!

Pentru evitarea zgârierii, această piesă de mobilier trebuie să fie montată pe o suprafață moale, de exemplu, pe un covor.

BG: ПРЕДУПРЕЖДЕНИЕ ЗА ИЗБЯГВАНЕ НА ДРАСКОТИНИ!

За да избегнете надраскване, тази мебел трябва да бъде сглобена на мека повърхност – например килим.

GR: ΠΡΟΕΙΔΟΠΟΙΗΣΗ ΓΙΑ ΤΗΝ ΑΠΟΦΥΓΗ ΓΡΑΤΣΟΥΝΙΩΝ!

Για την αποφυγή γρατσουνιών, το έπιπλο θα πρέπει να συναρμολογηθεί σε μαλακή επιφάνεια, όπως για παράδειγμα πάνω σε ένα χαλί.

PT: AVISO PARA EVITAR RISCOS!

Para evitar riscos, este móvel deve ser montado numa superfície macia (por exemplo, tapete).

RU: ПРЕДУПРЕЖДЕНИЕ ОТНОСИТЕЛЬНО ЦАРАПИН!

Во избежание нанесения царапин, сборку этой мебели необходимо выполнять на мягкой поверхности, например на ковре.

TR: ÇİZİLMELERİ ÖNLEMENE YÖNELİK UYARI!

Bu mobilyanın çizilmesini engellemek için montajını halı gibi yumuşak bir yüzeyin üzerinde yapın.

CN: 防刮警告!

为了避免刮伤家具，应在地毯等软面上进行组装。

- GB: IMPORTANT!**
It is important that any product which is assembled using any kind of screw is re-tightened 2 weeks after assembly, and once every 3 months - in order to assure stability through-out the lifespan of the product.
- DK: VIGTIG!**
Det er vigtigt, at alle produkter, der samles med alle former for skruer, efterspændes to uger efter samling samt hver tredje måned for at sikre, at produktet er stabilt i hele dets levetid.
- DE: WICHTIG!**
Es ist wichtig, bei jedem mit Schrauben montierten Produkt diese 2 Wochen nach dem Zusammenbau sowie einmal alle 3 Monate wieder anzuziehen, um die Stabilität des Produkts über die gesamte Lebensdauer hinweg zu gewährleisten.
- NO: VIKTIG!**
Det er viktig at alle produkter som monteres med skruer blir etterstrammet 2 uker etter montering, og hver 3. måned for å sikre stabiliteten gjennom hele produktets levetid.
- SE: VIKTIG!**
För alla produkter som monteras med skruv är det viktigt att dessa efterdras två veckor efter monteringen och därefter en gång var tredje månad. Detta för att säkerställa att produkten håller sig stabil under hela sin livslängd.
- FI: TÄRKEÄÄ!**
On tärkeää, että kaikki ruuvien avulla koottavat tuotteet kiristetään uudelleen 2 viikkoa kokoamisen jälkeen ja aina 3 kuukauden välein, jotta tuote pysyy vakaana koko käyttöikänsä ajan.
- PL: WAŻNE!**
Ważne jest, żeby każdy ze skręcanych produktów został ponownie dokręcony w ciągu 2 tygodni od montażu, a następnie sprawdzac co 3 miesiące czy śruby są dokręcone - w celu zapewnienia stabilności przez czas użytkowania produktu.
- CZ: DŮLEŽITÉ!**
U každého výrobku, který se sestavuje pomocí jakýchkoli šroubků, je důležité dotáhnout šroubky 2 týdny po sestavení a potom každé 3 měsíce, aby byla zajištěna stabilita po celou dobu životnosti výrobku.
- HU: FONTOS!**
Minden terméknél fontos, hogy bármilyen fajta csavarral is történik az összeszerelés, utána 2 héttel, majd 3 havi rendszerességgel szükséges a csavarok utánhúzása. Ezzel a termék teljes élettartamán keresztül biztosítható a stabilitása.
- NL: BELANGRIJK!**
Het is belangrijk om elk product dat met om het even welk soort schroef wordt gemonteerd, twee weken na montage en om de drie maanden, opnieuw wordt vastgeschroefd, om de stabiliteit van het product tijdens de hele levensduur te verzekeren.
- SK: DŮLEŽITÉ!**
Je dôležité, aby sa na akomkoľvek produkte, montovanom pomocou akýchkoľvek skrutiek, skrutky dotiahli po dvoch týždňoch od montáže, a jedenkrát v priebehu každých 3 mesiacov - tak sa zaručí stabilita počas celej životnosti produktu.
- FR: IMPORTANT!**
Il est important que tout produit monté à l'aide de vis soit resserré 2 semaines après son montage, puis tous les 3 mois, afin de garantir sa stabilité durant tout son cycle de vie.
- SI: POMEMBNO!**
Vsak izdelek, ki ga sestavite z uporabo kakršnihkoli vijakov morate 2 tedna po sestavitvi ponovno pregledati in vijake po potrebi priviti. To ponovite vsake 3 mesece, da bi zagotovili stabilnost izdelka skozi njegovo celotno življenjsko dobo.
- HR: VAŽNO!**
Važno je da se svi tipovi vijaka na bilo kojoj vrsti proizvoda koji se s pomoću njih sastavlja ponovno pritegnu 2 tjedna nakon sastavljanja te jednom svaka 3 mjeseca - kako bi se zajamčila stabilnost tijekom životnog vijeka proizvoda.
- IT: IMPORTANTE!**
È importante in ogni prodotto montato con viti serrare ben strette le viti 2 settimane dopo il montaggio e poi ogni 3 mesi per garantire la sua stabilità durante tutta la durata del prodotto.
- ES: IMPORTANTE!**
En el caso de los productos ensamblados, es importante volver a apretar los tornillos 2 semanas después del montaje y después cada 3 meses, para así preservar la estabilidad durante toda la vida útil del producto.
- BA: VAŽNO!**
Za sve proizvode sa vijčanim vezama, potrebno je izvršiti pritezanje 2 sedmice nakon sklapanja i svaka 3 mjeseca nakon toga, kako bi se osigurala stabilnost tokom cijelog životnog vijeka proizvoda.
- RS: VAŽNO!**
Važno je da svaki proizvod koji je sklopljen korišćenjem bilo kakvih šrafova bude ponovo pričvršćen 2 nedelje nakon sklapanja i jednom svaka 3 meseca - kako bi se obezbedila stabilnost tokom celog veka trajanja proizvoda.
- UA: УВАГА!**
Майте на увазі, якщо у процесі монтажу продукту використовуються гвинти будь-якого типу, їх треба повторно затягнути через 2 тижні після монтажу, а потім кожні 3 місяці. Це необхідно для того, щоб забезпечити надійне використання продукту протягом терміну його служби.
- RO: IMPORTANT!**
Este important ca şuruburile de orice tip, cu ajutorul cărora au fost montate produsele, să fie strânse din nou la 2 săptămâni după montare şi, apoi, o dată la 3 luni, pentru a se asigura stabilitatea de-a lungul duratei de viaţă a produsului.
- BG: ВАЖНО!**
Важно е всеки продукт, който е сглобен с помощта на винтове, да бъде затегнат 2 седмици след сглобяването, и веднъж на всеки 3 месеца, за да се гарантира стабилност през цялото време на използване на продукта.
- GR: ΣΗΜΑΝΤΙΚΟ!**
Για κάθε προϊόν που συναρμολογείται με βίδες είναι σημαντικό αυτές να ενασφίγγονται 2 εβδομάδες μετά τη συναρμολόγηση και μία φορά κάθε 3 μήνες, για τη διασφάλιση της σταθερότητας σε όλη τη διάρκεια ζωής του προϊόντος.
- PT: AVISO IMPORTANTE!**
É importante, em cada produto montado com parafusos, reapertar os mesmos 2 semanas após a montagem e uma vez a cada 3 meses para garantir a estabilidade do produto ao longo de toda a sua vida útil.
- RU: ВАЖНО!**
В любом изделии, собранном с использованием винтов любого типа, необходимо через 2 недели после сборки и в дальнейшем каждые 3 месяца подтягивать винты, чтобы обеспечить прочность изделия в течение срока эксплуатации.
- TR: ÖNEMLİ!**
Vida kullanılarak yapılan her türlü ürün montajı için montajdan 2 hafta sonra vidaların yeniden sıkıştırılması ve kullanım süresi boyunca ürün istikrarının sağlanması için de her 3 ayda bir vidaların sıkıştırılması önem arz eder.
- CN: 重要提示!**
使用任何类型的螺钉组装的产品，必须在组装 2 周后重新拧紧，并且每 3 个月重新拧紧一次，以确保产品在整个使用期内结实稳固。

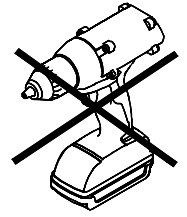

A x 4

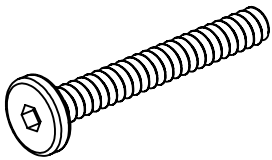

M6x45 mm

B x 13

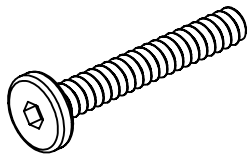

M6x40 mm

C x 4

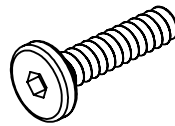

M6x25 mm

D x 21



Ø16x1 mm

E x 1

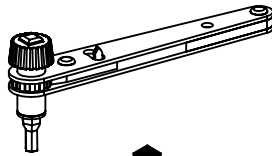

4 mm

F x 1

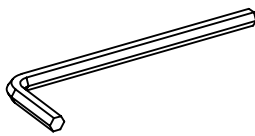

4 mm

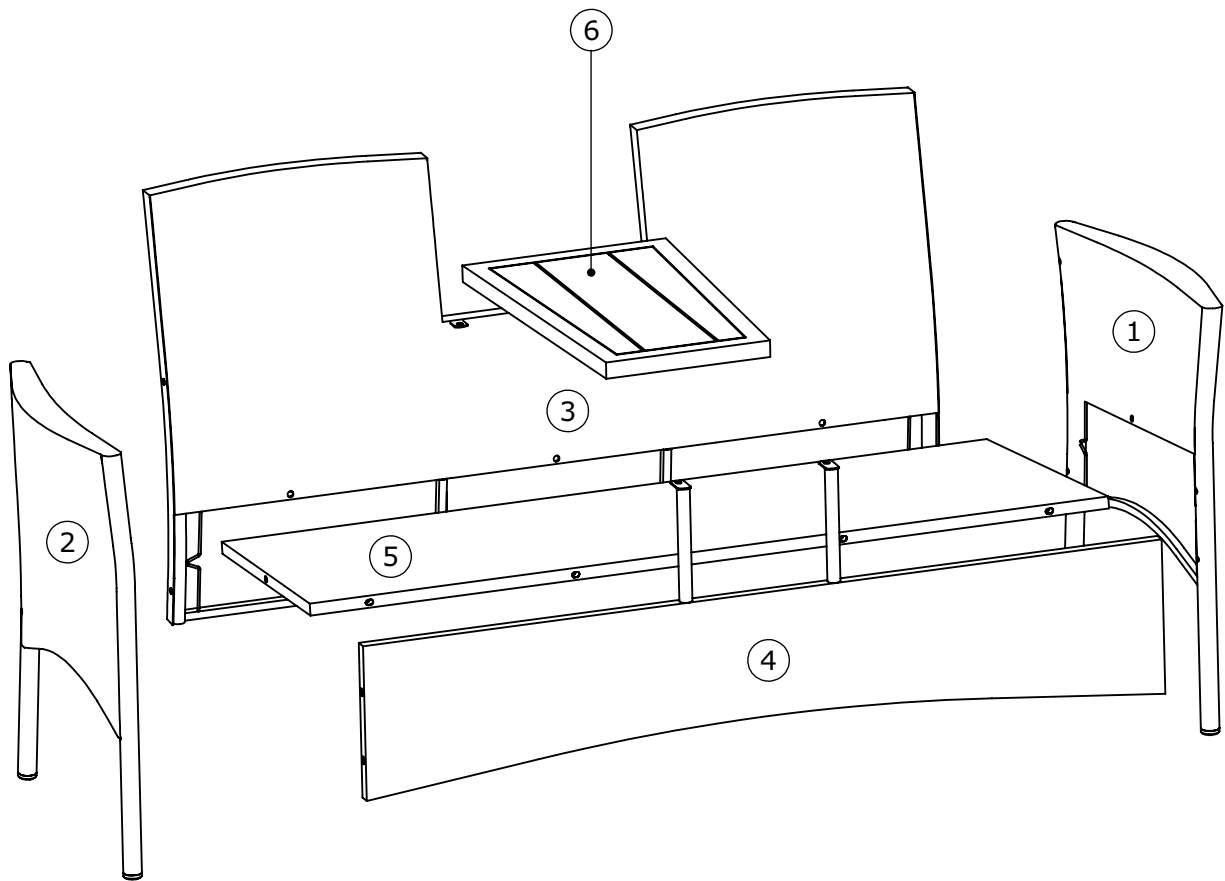

BOX 1/1

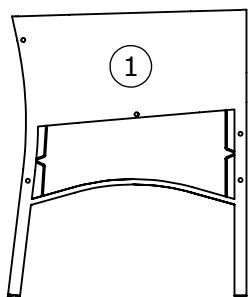

540x665x85 mm

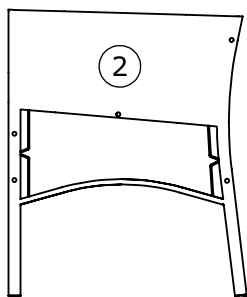

540x665x85 mm

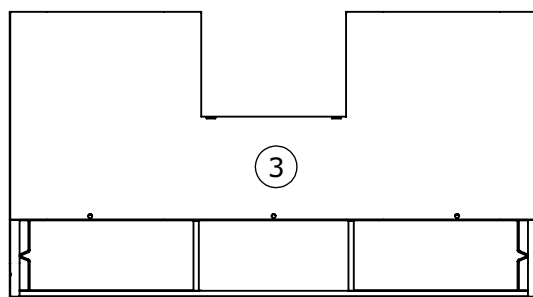

1200x660x110 mm

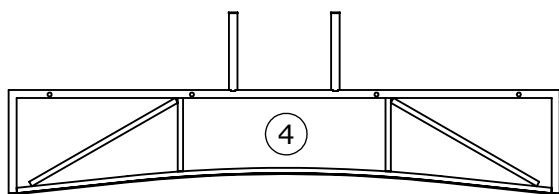

1240x420x40 mm

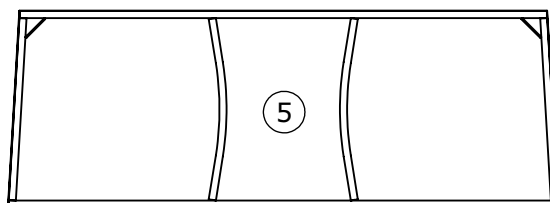

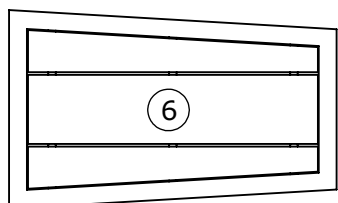

1240x450x24 mm



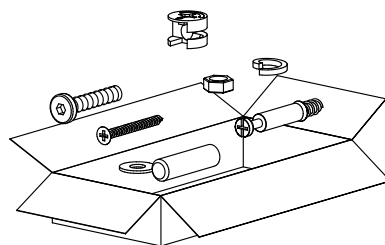

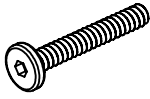

524x315x33 mm

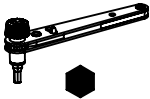



1



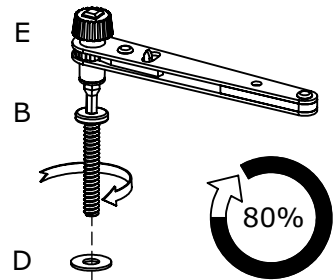
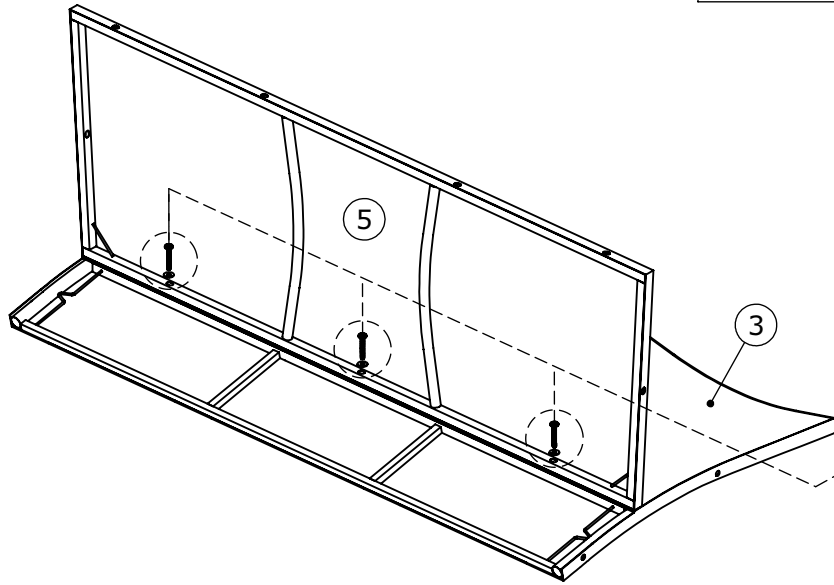

B x 3  M6x40 mm	D x 3  Ø16x1 mm	E x 1  4 mm	
--	--	--	--

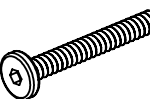
	A  M6x45 mm	B  M6x40 mm	C  M6x25 mm
--	--	--	--

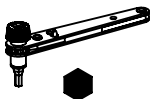



2

A x 2  M6x45 mm	D x 2  Ø16x1 mm	E x 1  4 mm	
--	--	--	--

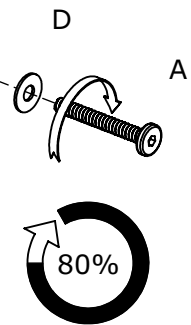
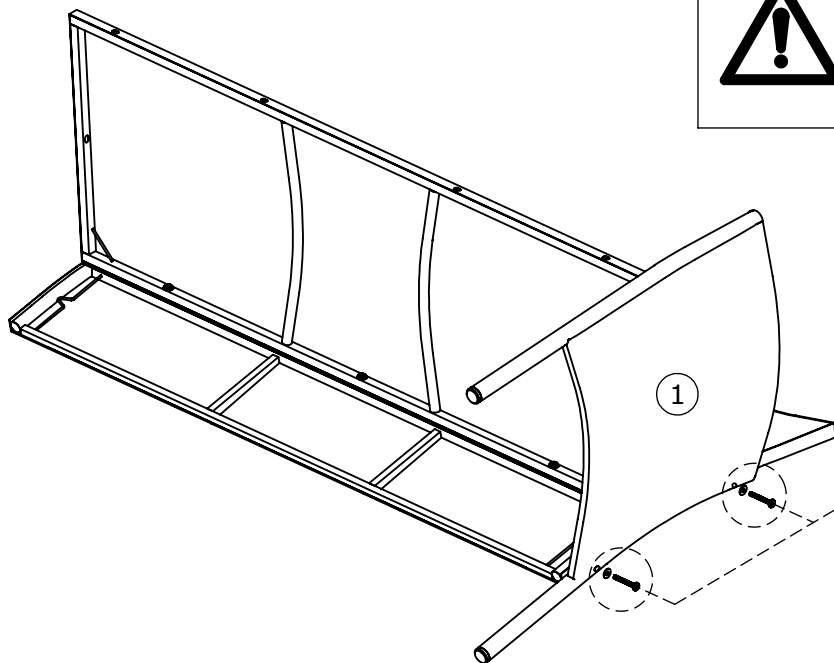
	A  M6x45 mm	B  M6x40 mm	C  M6x25 mm
--	--	--	--



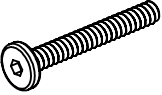

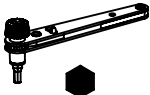
3

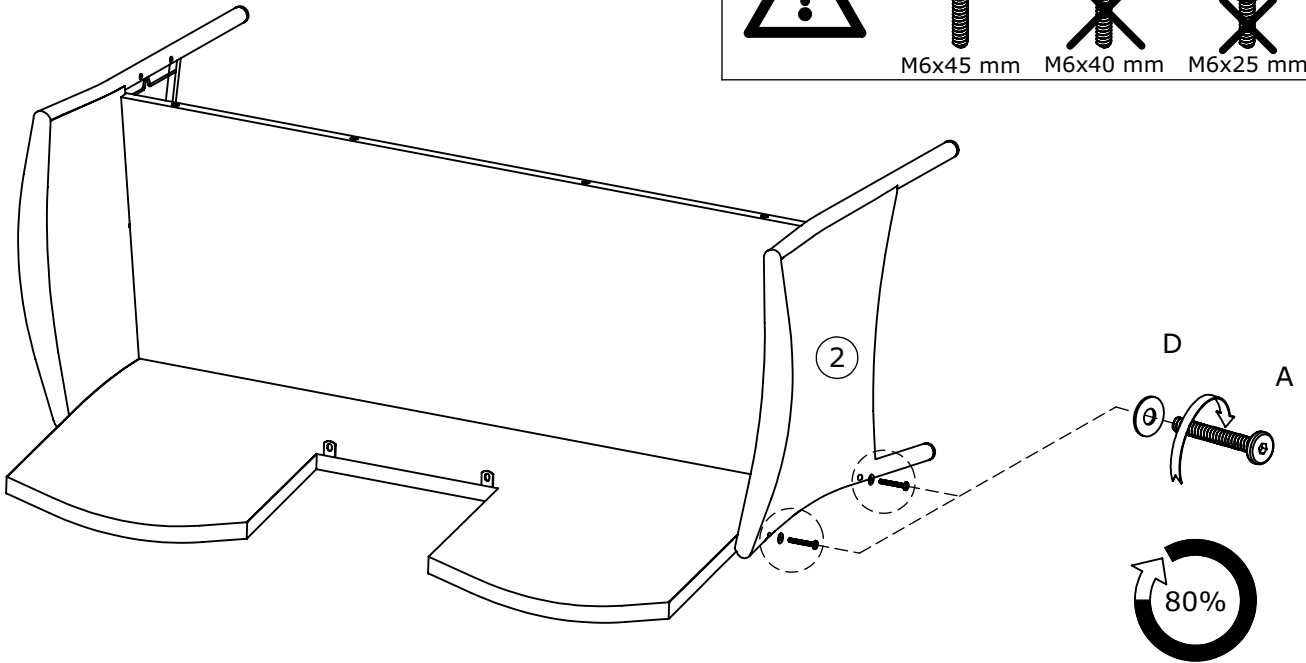
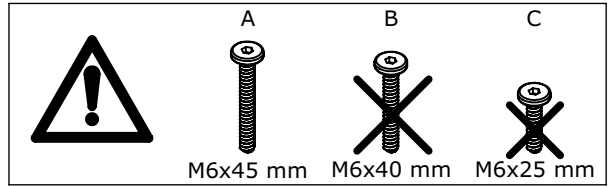
A x 2  M6x45 mm	D x 2  Ø16x1 mm	E x 1  4 mm	
--	--	--	--



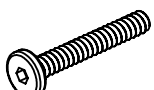

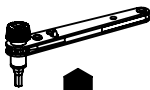
4

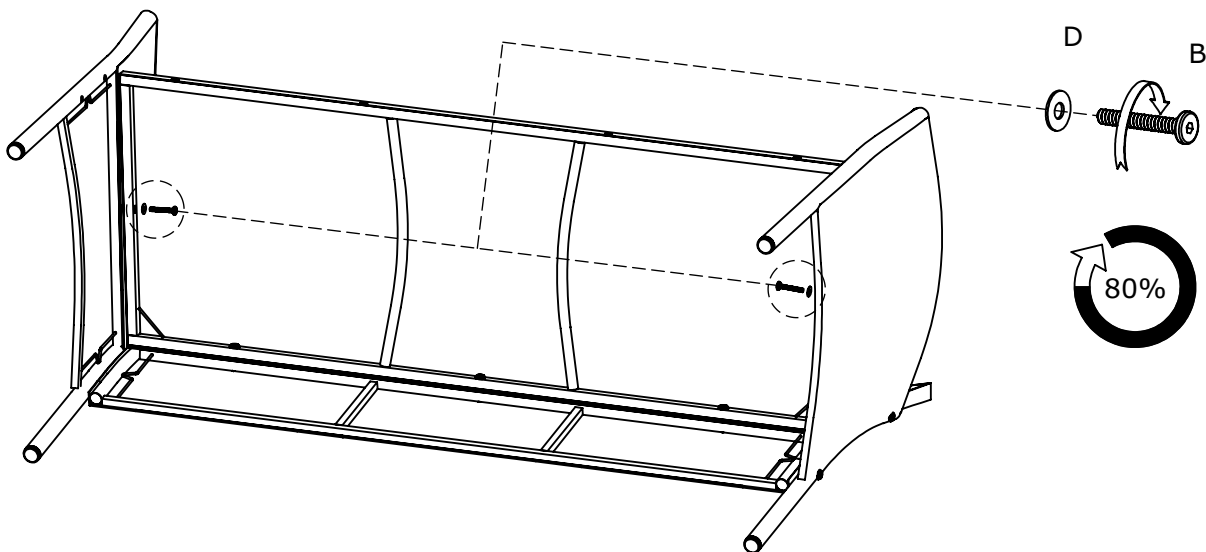
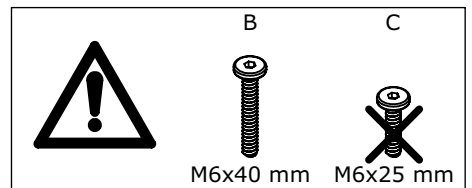
B x 2  M6x40 mm	D x 2  Ø16x1 mm	E x 1  4 mm	
--	--	--	--



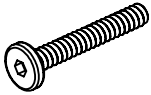

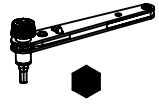
5

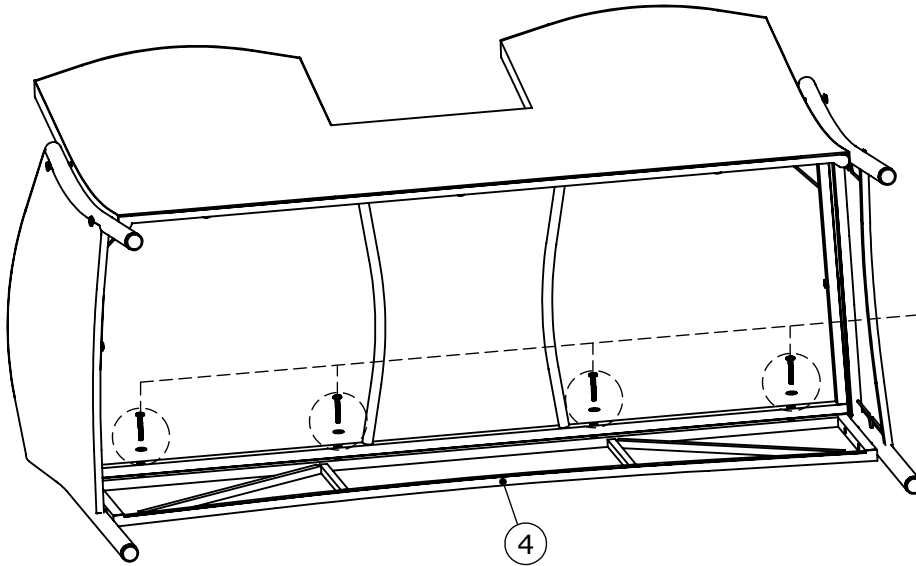
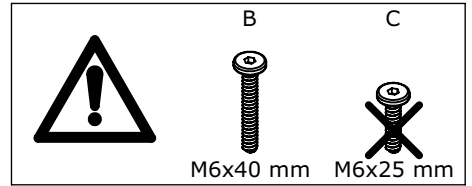
B x 4  M6x40 mm	D x 4  Ø16x1 mm	E x 1  4 mm	
--	--	--	--



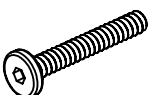

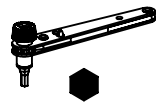
6

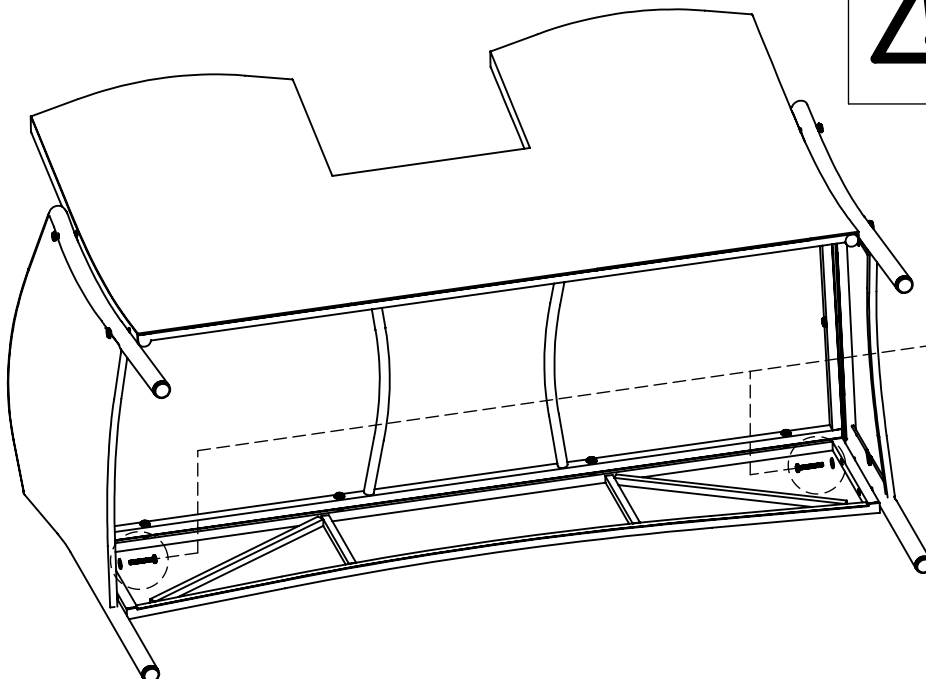
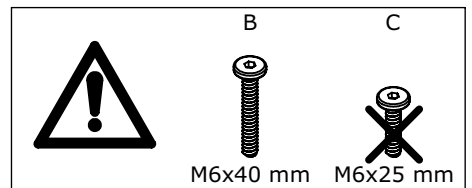
B x 2  M6x40 mm	D x 2  Ø16x1 mm	E x 1  4 mm	
--	--	--	--



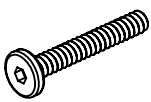

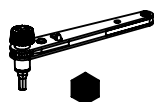
7

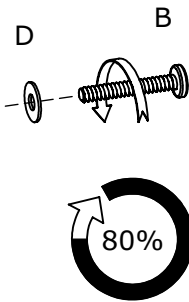
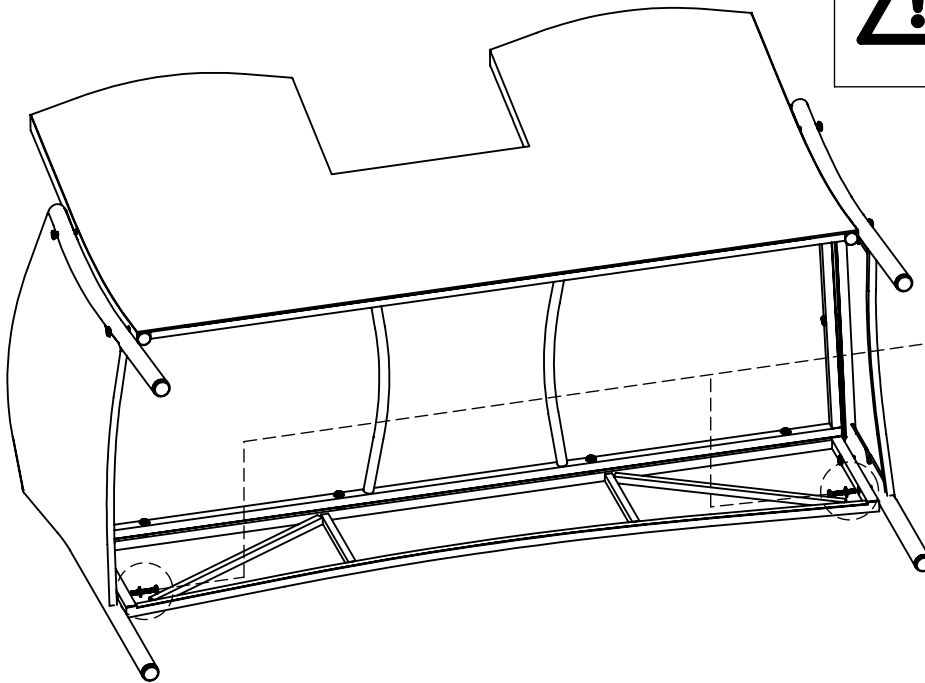
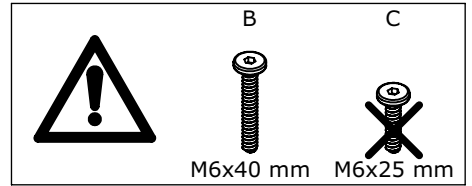
B x 2  M6x40 mm	D x 2  Ø16x1 mm	E x 1  4 mm	
--	--	--	--



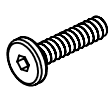

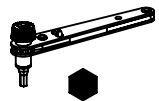
8

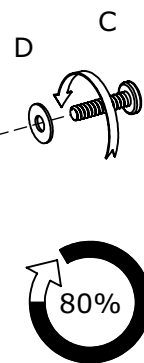
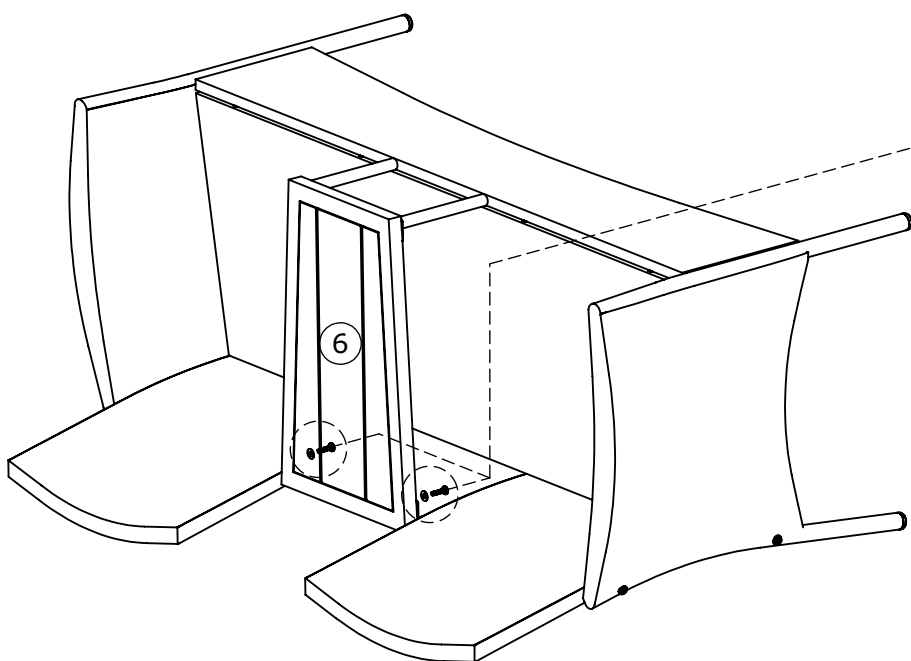
C x 2  M6x25 mm	D x 2  Ø16x1 mm	E x 1  4 mm	
--	--	--	--

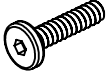

9

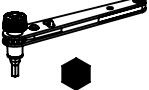
C x 2  M6x25 mm	D x 2  Ø16x1 mm	E x 1  4 mm	
--	--	--	--

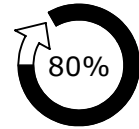
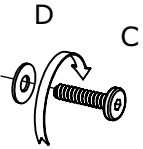
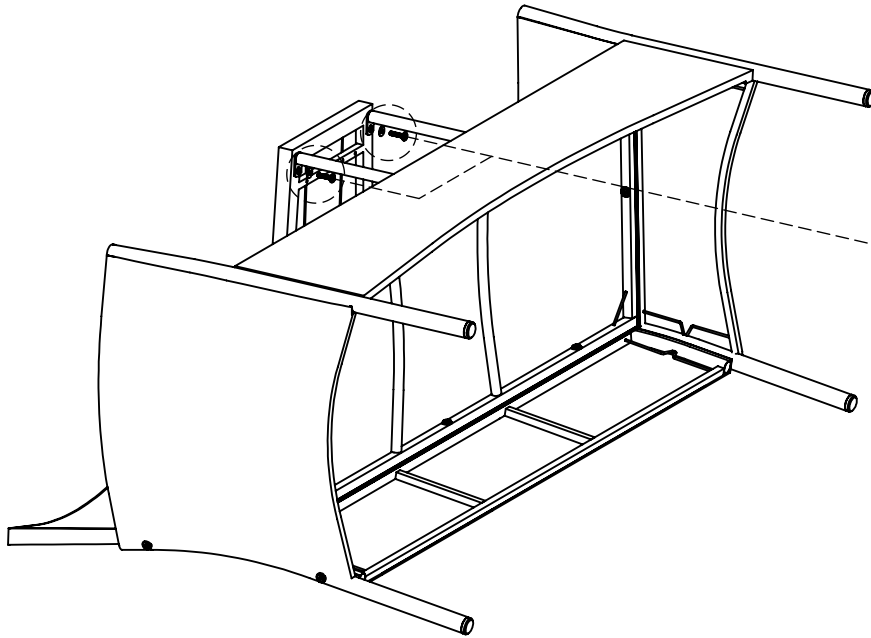

10

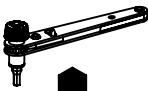
E x 1  4 mm	
--	--

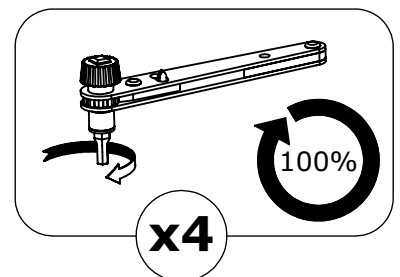
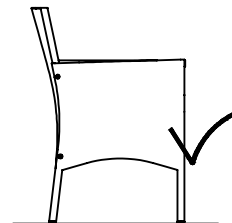
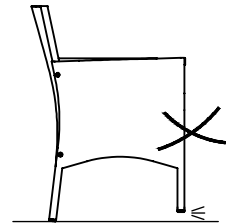
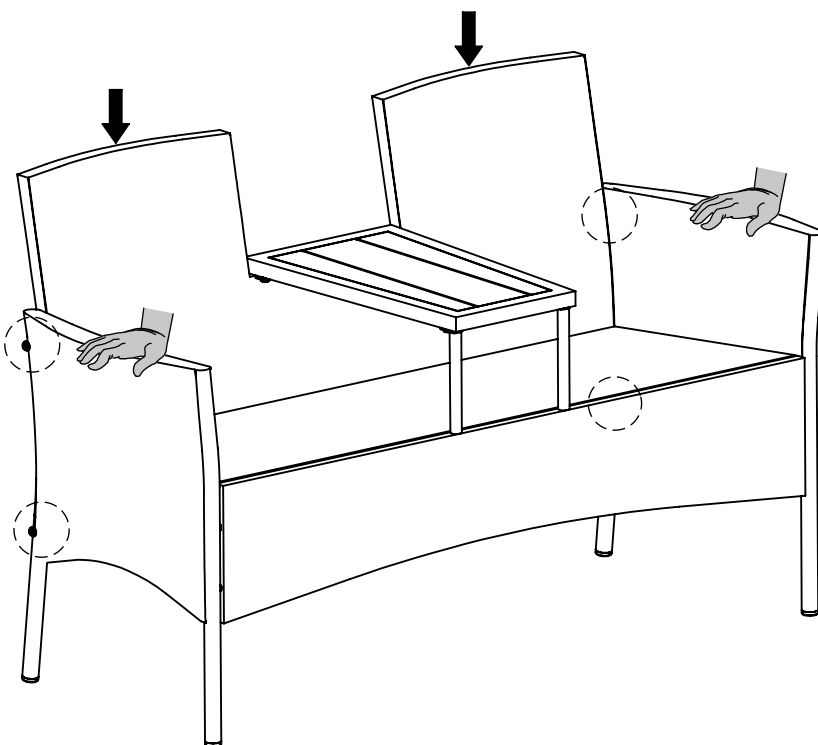

11

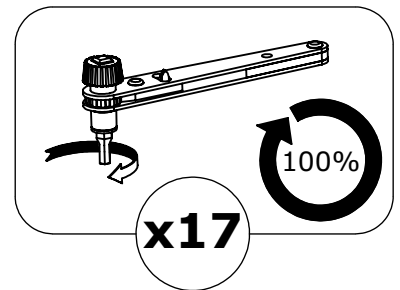
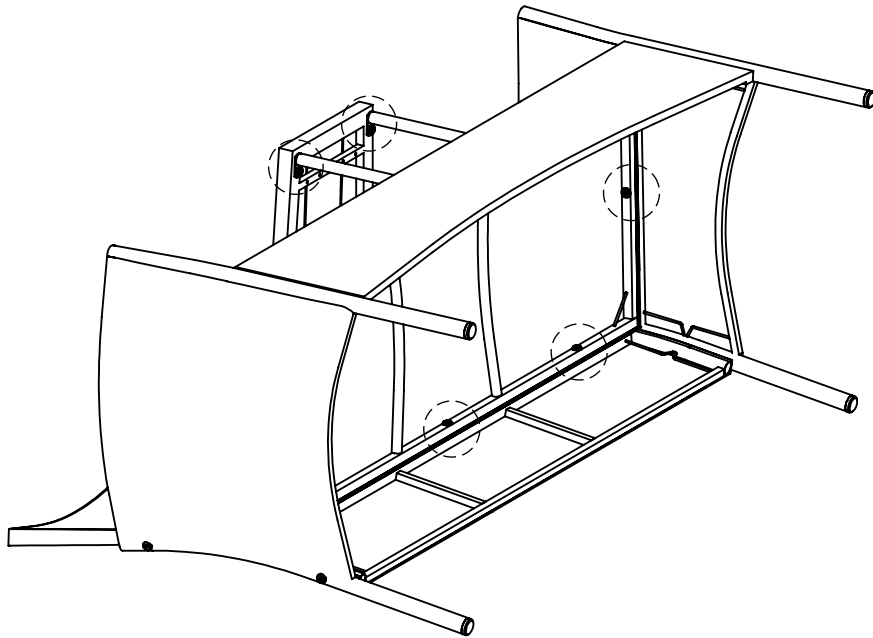
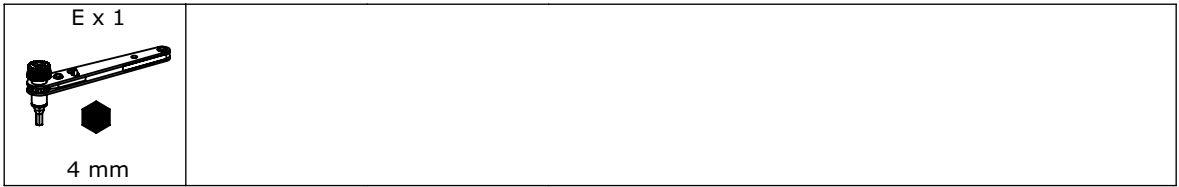

12

